

CERTIFIED TESTING LABORATORIES

Architectural Division • 7252 Narcoossee Rd. • Orlando, FL 32822
(407) 384-7744 • Fax (407) 384-7751
Web Site: www.ctlarch.com
E-mail: ctlarch.com

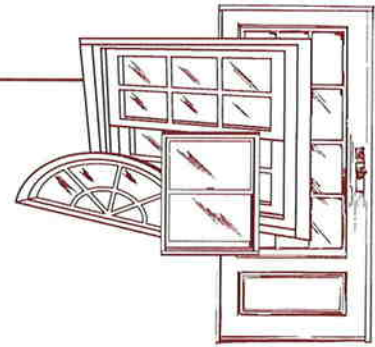

Report No.: CTLA-1743W
Report Date: September 20, 2007

STRUCTURAL PERFORMANCE TEST REPORT

Test Requested By - Glass Craft Door Co.
2002 Brittmoore Rd.
Houston, Texas 77043

Tests Conducted: ASTM E 330-02 "Test Method for Structural Performance of Exterior Windows, Curtain Walls and Doors by Uniform Static Air Pressure Difference."

Test Specimen

Design Pressures In-swing + 50.0psf -50.0psf (With surface bolts)

(1) DESCRIPTION OF SERIES:

Model Designation 6'-0" x 8'-0" Portobello / Estancia Arch Top Hardwood Double Glazed Doors
In-swing

Overall Size

& Configuration: Two (2) Operable In-swing Panels 74.000" wide x 99.000" high overall- X/X

No. & Size of Doors

(1) Active Arch Top (2/3 lite panel)	36.000" wide x 96.000" high
(1) Passive Arch Top w/astragal (2/3 lite panel)	36.750" wide x 96.000" high

(2) MATERIAL CHARACTERISTICS:

Materials – Hardwood panels, header, jambs, and astragal with an aluminum composite filled fixed In-swing threshold by Endura (As stated by manufacturer).

Frame Construction -

The double door frame consists of two (2) hinge jambs, one (1) header, and one (1) sill/threshold. Reference drawing # (Portobello/Estancia ARCH CTL-004). The frame is constructed of kerfed solid hardwood and measured 4.625" wide x 1.250" thick. The frame head is mortised and butted to the side jambs and attached with four (4) #8 x 3.000" Phillips C.S. Wood Screws on each side. The threshold was mortised and butted and attached to the side jambs with three (3) #8 x 3.000" Phillips C.S. Wood Screws on each side. The sill is an aluminum fixed composite filled standard in-swing threshold that measured 5.750" wide x 1.500" high manufactured by Endura. Both hinge jambs are notched for four (4) 4.000" butt hinges.

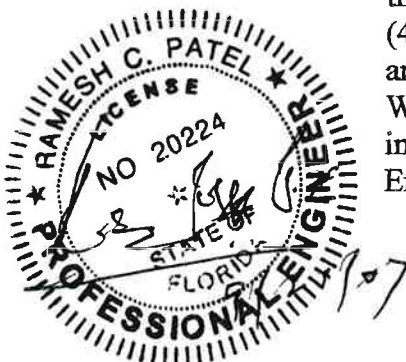

Panel Construction: One (1) wood "T" Astragal was located on the lock-stile of the passive panel and (2/3 Passive Lite) was constructed of one (1) solid hardwood piece. The wood "T" Astragal measured 1.406" wide x 3.125" high x full length of panel. The "T" astragal was secured to the lock stile of the passive panel with 1.500" brad nails and an adhesive compound. The active and passive panels were constructed as follows.

One (1) top rail measured 6.500" wide by 24.500" long by 1.750" thick and constructed with solid hardwood pieces glued together with a hardwood laminate (0.19" thick) adhered to the surface.

One (1) intermediate rail measured 6.500" wide by 24.500" long by 1.750" thick and constructed with solid hardwood pieces glued together with a hardwood laminate (0.19" thick) adhered to the surface.

One (1) Hinge-stile measured 6.0625" wide by 89.000" high by 1.750" thick and constructed with solid hardwood pieces glued together with a hardwood laminate (0.19" thick) adhered to the surface.

One (1) lock-stile measured 6.0625" wide by 96.000" high by 1.750" thick and constructed with solid hardwood pieces glued together with a hardwood laminate (0.19" thick) adhered to the surface.

One (1) bottom rail measured 9.500" wide by 24.500" long by 1.750" thick and constructed with solid hardwood pieces glued together with a hardwood laminate (0.19" thick). Top rail utilized two (2) hard wood dowel (.500" x 5.000") construction with adhesive compound secured to the lock stile and the hinge stile. Intermediate rail utilized two (2) hard wood dowel (.500" x 5.000") construction with adhesive compound secured to the lock stile and the hinge stile. Bottom rail utilized four (4) hard wood dowel (.500" x 5.000") construction with adhesive compound secured to the lock stile and the hinge stile. The door panel was constructed of solid hardwood held into the stiles and rails with cope and stick construction. Panel measured 12" high x .875" thick. Ref. Dwg. #(Portobello/Estancia ARCH CTL-004).

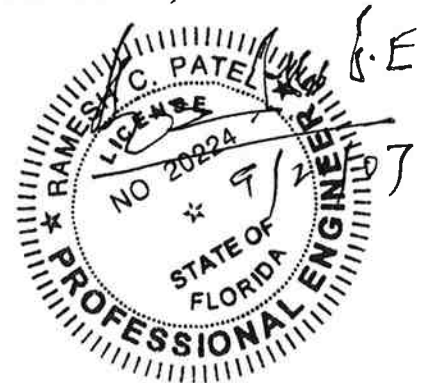

Panel Construction: One (1) top rail measured 6.500" wide by 24.500" long by 1.750" thick, and (2/3 Active Lite) constructed with solid hardwood pieces glued together with a hardwood laminate (0.19" thick) adhered to the surface.
One (1) intermediate rail measured 6.500" wide by 24.500" long by 1.750" thick and constructed with solid hardwood pieces glued together with a hardwood laminate (0.19" thick) adhered to the surface.
One (1) Hinge-stile measured 6.0625" wide by 89.000" high by 1.750" thick and constructed with solid hardwood pieces glued together with a hardwood laminate (0.19" thick) adhered to the surface.
One (1) lock-stile measured 6.0625" wide by 96.000" high by 1.750" thick and constructed with solid hardwood pieces glued together with a hardwood laminate (0.19" thick) adhered to the surface.
One (1) bottom rail measured 9.500" wide by 24.500" long by 1.750" thick and constructed with solid hardwood pieces glued together with a hardwood laminate (0.19" thick). Top rail utilized two (2) hard wood dowel (.500" x 5.000") construction with adhesive compound secured to the lock stile and the hinge stile. Intermediate rail utilized two (2) hard wood dowel (.500" x 5.000") construction with adhesive compound secured to the lock stile and the hinge stile. Bottom rail utilized four (4) hard wood dowel (.500" x 5.000") construction with adhesive compound secured to the lock stile and the hinge stile. The door panel was constructed of solid hardwood held into the stiles and rails with cope and stick construction. Panel measured 12" high x .875" thick. Ref. Dwg. # (Portobello/Estancia ARCH CTL-004).

Glazing Method: -

One (1) active, one (1) passive panel (2/3 clear lite panel) consisted of : .500" overall tempered glass glazed consisting of : **One (1) interior lite:** .125" Tempered glass, .250" spacer system with an with a "U" shaped rubber insert. **One (1) exterior lite:** .125" Tempered glass. Tempered glass glazed with Tremco "Dynamic" Polyurathane with a .500" glazing bite. Glass was captured on the interior perimeter with one (1) pieces of decorative hardwood molding strips that measured 1.419" wide x 1.030" high. Each piece of molding was secured to hinge and lock stiles and 18 Ga x 1.500" Brad nails. Reference drawing # (Portobello/Estancia ARCH CTL-010).

Daylight Opening -

(1) Active (2/3 lite panel)	21.625" wide x 55.875" high
(1) Passive (2/3 lite panel)	21.625" wide x 55.875" high

Weather-stripping

Q-Lon weather-stripping located on the jambs, header, and Astragal.
One (1) piece length of each side jamb and (1) piece length of astragal. (2) four fin vinyl bottom door sweeps one per each panel secured with staples to the bottom of the panels.



Hardware -

Four (4) 4" x 4" Penrond 5/8" radius hinges per each hinge stile of the active and passive panel secured to the fixed stile utilizing four (4) # 8 x 1.000" Phillips flat head S.M.S. and frame jamb utilizing two (2) # 8 x 3.000" and two (2) # 8 x 1.000" Phillips flat head S.M.S. located at 11.000", 33.250", 55.750" and 78.000" c/l measuring from the top of each panel to the bottom . One (1) Slege door knob and one (1) Slege Deadbolt Grade II were inserted into a wood lock box on the lock stile of operable door. The handle set was located at 36.000" centerline from the bottom of the door panel and the deadbolt was located at 41.500" centerline from the bottom of the door panel. The metallic latch strikes for the handle set and deadbolt were located at 36.000" and 41.500" centerline from the bottom of the frame latch jamb. Specimen utilized four steel Surface bolts located at the top and bottom of active and passive door panel that measured .750" wide x 8.000" long. The surface bolts were Rockwood 580 type steel and were thru-bolted to the exterior of the lock and latch stiles with four (4) 10/32 x 1.000" Phillips F.H. Sex Bolts. There were four metallic strike plates for surface bolts to insert with two (2) at the frame head and two (2) at the sill/threshold. Reference drawing # (Portobello/Estancia Arch CTL-003).

Weepholes -

N/A

Muntins -

N/A

Reinforcement -

N/A

Sealant -

Silicone caulking as needed to seal unit into rough opening.
All hairline joints between the frames were sealed with Tight Bond II Exterior Marine glue.

Additional Description -

Specimen was installed in a 2" x 12" S.P.F. wood test buck.

(3) INSTALLATION:

Screws and Method of Attachment – The specimen was secured to the 2" x 12" S.P.F. wood test buck as follows: Reference drawing # (Portobello/Estancia ARCH CTL-016).

Eight (8) # 8 x 3.000" Phillips flat head wood screws per each frame jamb (two per each hinge location) to the wood buck located at located at 9.000", 12.000", 31,000", 34.000", 53.500", 56.500, 76.000" and 79.000" measuring from frame head to frame sill/threshold.

Six (6) #10 x 3.000" Phillips flat head wood screws in the frame head– Located at 8.000", 19.000", 35.000", 42.000", 54.000" and 66.000" measuring from left jamb to right jamb.

Eight (8) # 8 x 1.250" Phillips C/S flat head S.M.S. at Frame Sill/ Threshold – Located at 6.000", 14.000", 23.000", 32.000", 41.000", 50.000", 59.000" and 68.000" measuring from left jamb to right jamb.

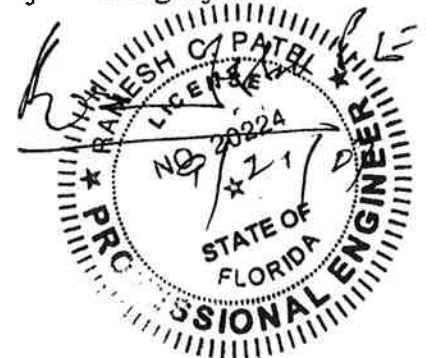

Performance Test Results

<u>Paragraph</u>	<u>Title of Test</u>	<u>Method</u>	<u>Measured</u>	<u>Allowed</u>
ASTM E330-02				
2.1.4.2/4.4.2	Uniform Load Structural			
	Permanent Deformation	Ten (10) second duration		
(D/P + 50)	@ 75.0 psf Positive	Loc #1	0.123"	0.384"
(D/P - 50)	@ 75.0 psf Negative	Loc #1	0.020"	0.384"

Location (1) - Max. allowable Perm. Set after test load at center mid-span of the vertical astragal (0.4% of 96" span) = 0.384"

Note: Unit was tested with surface bolts on the top and bottom of active and passive panel.

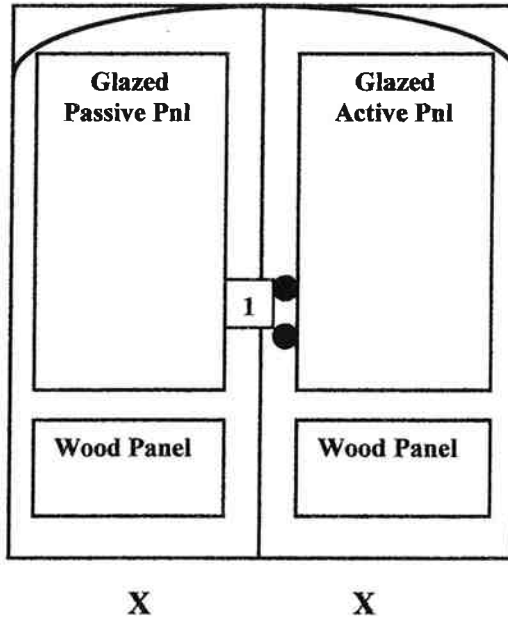

Test Date: September 12, 2007 thru September 14, 2007.

(5) DRAWINGS TO BE SUBMITTED:

- 1. Portobello/Estancia ARCH-CTL-001 thru Portobello/Estancia ARCH-CTL-0017.

Comment: Nominal 2-mil polyethylene film was used to seal against leakage during structural loads. The film was used in a manner that did not influence the test results.



Remarks: The results obtained and reported apply only to the specimens tested.

Detailed drawings were available for laboratory records and comparison to the test specimen at the time of this report. A copy of this report along with representative sections of the test specimen will be retained by CTL for a period of four (4) years. The results obtained apply only to the specimen tested.

This test report does not constitute certification of this product, but only that the above test results were obtained using the designated test methods and they indicate compliance with the performance requirements (paragraphs as listed) of the above referenced specifications.

Certified Testing Laboratories assumes that all information provided by the client is accurate and that the physical and chemical properties of the components are as stated by the manufacturer.

Certified Testing Laboratories, Inc.

Observers:

Gene Denley- Glass Craft Door Co.

All Tests Certified and Witnessed by

Ramesh Patel- P.E.

Ted Scanlon- CTL

Steve Gibbs- CTL

Gary Nations- CTL



Michael Miller
Senior Laboratory Technician
Architectural Division

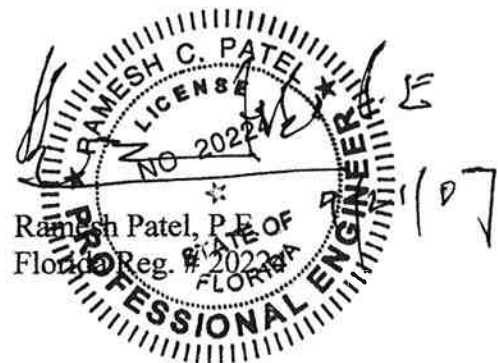

Cc: Glass Craft Door Co. (2)
NAMI (1)
Ramesh Patel (1)
File (1)

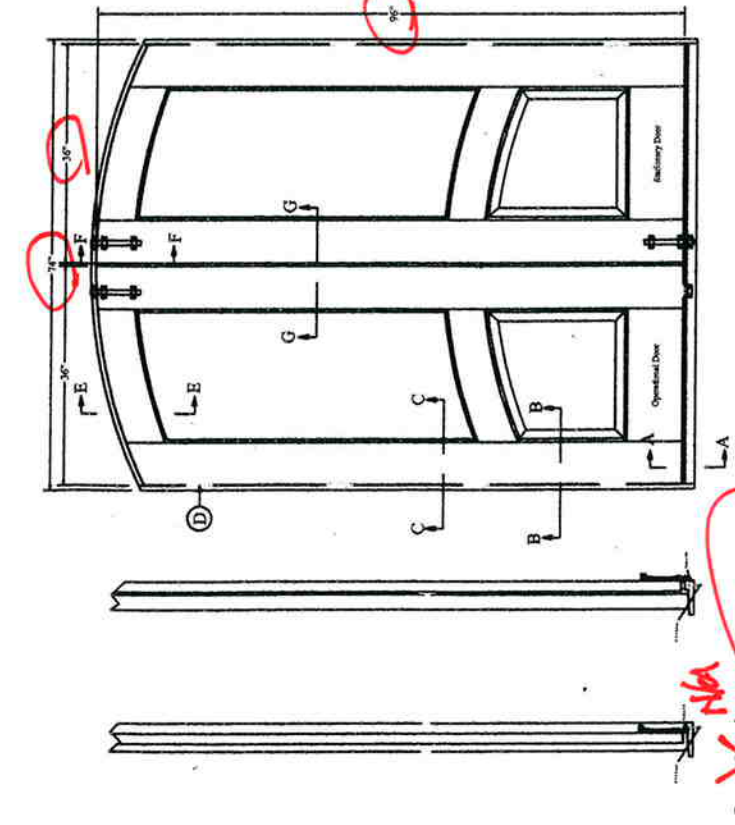

ELEVATION

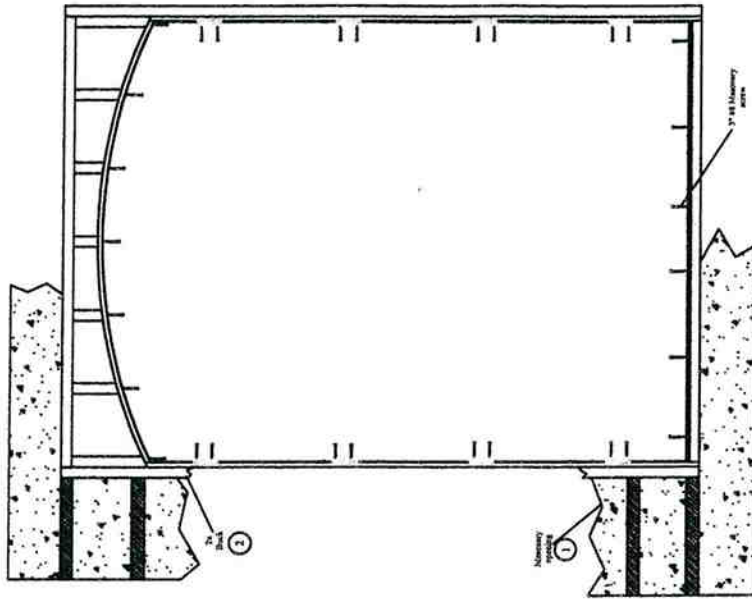

ANCHORING LAYOUT

Set frame sill in concrete
or bed of caulk

Inside View / In swing & Out ~~Swing~~

Out ~~Swing~~ In Swing



CTL
ESTIMATING LABORATORIES

ARCHITECTURAL DIVISION
7252 NARCOOSSEE ROAD
ORLANDO, FLORIDA 32822

Glass*Craft
Portobello / Estancia Arch Top
Hardwood Double Glazed Doors

CTLA No. 1743W

Date Verified: 9.24.07

Verified By: K-10

CTL-001